

For products with serial number 220401001 and later.

COMPLETE USER MANUAL

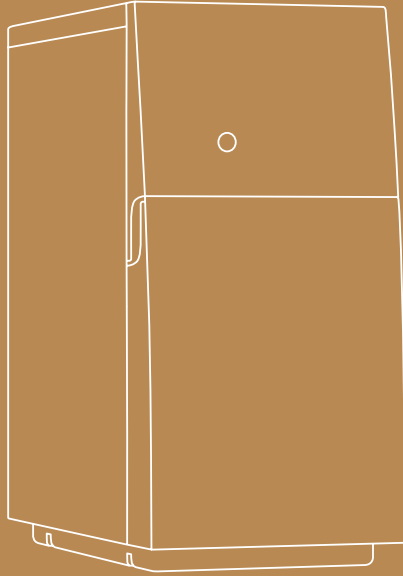

BLUEWATER PRO

WATER PURIFIER





CONTENTS

INTRODUCTION	05
About this manual	05
Limited warranty	05
Environment information	05
Recycle / Disposal	05
Symbols	05
Safety instructions	06
Safety information	06
PRODUCT OVERVIEW	08
Models	08
Pro outside	08
Pro inside and replacement components	09
Control panel	09
Data plate	10
Move the water purifier	10
SYSTEM OVERVIEW	11
System description	11
Leak protection system	12
Low pressure protection	12
Water production	13
INSTALLATION	14
Unpack Pro	15
Position Pro	16
Install purified water faucet	16
Install inlet water connection	17
Install drain water connection	17
Connect the water purifier	18
Commissioning flush	19
Do a check for leaks	25
MAINTENANCE	26
Each month	27
Each 4-6 months	28
Each 6-12 months	35
Each year	36
Other	36
TECHNICAL INFORMATION	47
Technical data	47
Requirements for inlet water to water purifier	47
TROUBLESHOOTING	49
How to solve simple problems	49
Product performance	51

INTRODUCTION

About this manual

This manual contains complete instructions for the Pro. It provides the necessary instructions to safely install, operate, maintain, and troubleshoot this device.

Original language

The original language of this instruction is English.

Printing options

This manual may be printed double sided on US Letter, A4 or A5 booklet.

Limited warranty

Refer to www.bluewatergroup.com/warranty for more information on Limited warranty.

Environment information



The water purifier is more efficient when purifying a larger amount of water at a time. Example: Filling several one litre containers is more efficient per litre than just filling one litre at each use.



80% of the water purifier components and packaging are labeled to help you recycle and discard correctly.

Recycle / Disposal

Contact your Bluewater dealer before disposing of the water purifier, as it can be refurbished and has many recyclable components. If disposing, disconnect the plug from the electrical supply and cut the electrical cord at the point where it enters the appliance. Make sure that children do not play with the leftover electrical cord.

For information on filter recycling or disposal, contact your Bluewater dealer.



Appliances bearing this symbol must be deposited at the designated local reception point for the disposal of electrical and electronic equipment. This product may not be disposed of using the normal household refuse collection processes.

Symbol

The following symbol can be found on the water purifier:

Symbol	Description
	The ETL Listed Mark is proof that the device has been independently tested and meets the applicable published standard.

Safety instructions

Before you install or operate the device, you must read the safety information. Obey the instructions in this manual to prevent injuries, or damage to the equipment. This manual contains CAUTIONS and NOTES that are applicable for the safe operation of the device.

 A CAUTION symbol identifies conditions that can cause injury, or damage to the equipment.
DO NOT USE Pro unless all cautionary conditions listed below have been understood and met.

 A NOTE symbol identifies important information for trouble free and optimal use of the water purifier.

Safety information

 Installation of the water purifier must comply with all applicable local regulations and plumbing codes. Contact your Bluewater dealer if you have questions. Bluewater, as the manufacturer, has no responsibility for water purifier installations.

Be aware! Do not use or drink the water before "PURIFICATION LEVEL II or LEVEL III" light turns green.

 When the system has been on standby, turn on the faucet and let the water run until "PURIFICATION LEVEL II or LEVEL III" light turns green before using or drinking the purified water. Do not drink the water during "PURIFICATION LEVEL I".

 This appliance can be used by children who are more than 8 years old. It can also be used by persons with reduced physical, sensory, or mental capabilities or lack of experience and knowledge, if they have been given supervision or instruction about the use of the appliance in a safe way and understand the hazards involved. Children shall not play with the appliance. Cleaning and user maintenance shall not be made by children without supervision.

 Only authorized technicians, distributors, or dealers approved by Bluewater can repair or modify parts of the water purifier. If not performed adequately, this can make it operate incorrectly, and lead to injury and damage not covered by warranty.

Pro is a reverse osmosis system. It contains a replaceable membrane that is very important for effective reduction of total dissolved solids (TDS). Replace this membrane regularly. Test the purified water periodically using a TDS/Conductivity tester at least one time every year to make sure that Pro performs correctly. For options, contact your Bluewater dealer. If there is any indication that the purified water tastes, smells bad, is cloudy, or there is a presence of particles, do not drink.



We recommend only approved technicians, distributors or Bluewater service personnel perform installations, servicing and repairs on the water purifier. If not performed adequately, this can make it operate incorrectly, and lead to injury and damage not covered by warranty.



Only use original replacement cartridges and parts from Bluewater. For the spare parts catalogue, see www.bluewatergroup.com. For purchase information, contact your Bluewater dealer.



The inlet water supply must meet the requirements stated in "REQUIREMENTS FOR INLET WATER to water purifier" [pages 47-48](#).



Connect the water purifier to an earthed/grounded electrical supply. Use a plug that is easy to access after installation. Only an approved electrician must do permanent wiring on the system. Incorrect installation can lead to damage or make the water purifier dangerous to use.



Do not use the power cord if there are visible signs of damage on it. If the power cord is damaged, a qualified electrician must replace it to prevent danger.



Do not use Pro without filters. This can cause damage to the system. The filters can be removed when Pro is cleaned or put into storage.



If the water purifier is disconnected from water and electricity for >5 days, store it as described in this Complete User manual. See "Put into storage" on [pages 39-41](#).



If the water purifier is disconnected from water and electricity for >5 days, store it as described in this Complete User manual. See "Put into storage" on [pages 39-41](#).



PRODUCT OVERVIEW

Models

Model	Capable of handling higher TDS, including brackish inlet water	Suitable for commercial use without an automatic shutoff	Clean water rinse valve suitable for environments where extra high water quality is required
Pro 400C-HF		✓	
Pro 400C-HR		✓	
Pro 400BC-HR	✓	✓	
Pro 400CV-HR		✓	✓
Pro 400BCV-HR	✓	✓	✓
Pro 600C-HF		✓	
Pro 600CV-HR		✓	✓

Pro outside

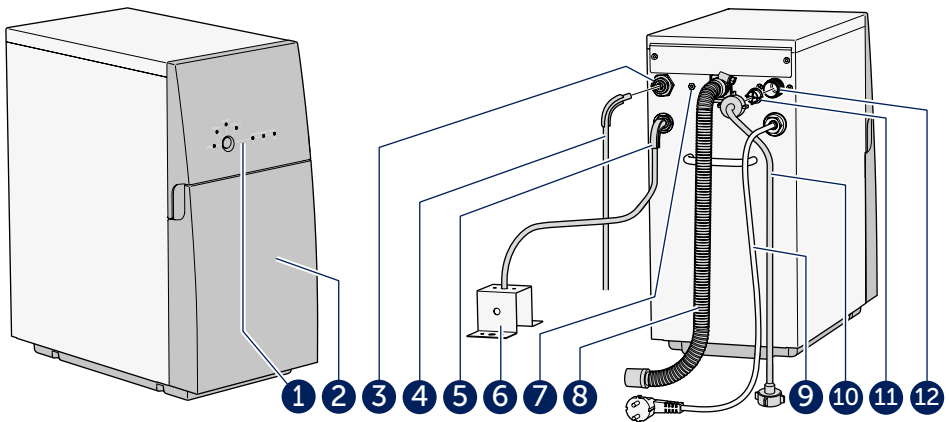

Figure 1. Pro outside

Pos	Description	Pos	Description
1	Control panel	7	Electrical connection for faucet (optional)
2	Front cover	8	Drain water hose
3	Clean water connection	9	Power cord
4	Clean water tube	10	Feed water tube
5	Rinse water tube (only for CV models)	11	Grid filter
6	Air-gap bracket (only for CV models)	12	Feed water connection

Pro inside and replacement components

Pos	Description	Part Number
1	Base plate	150706401-SP
2	FILTER I, Pro 600: Carbon Block	919240005
	FILTER I, Pro 400: Sediment filter	919240002
3	FILTER II, Pro 600: Carbon Block	919240005
	FILTER II, Pro 400: Carbon GAC	919240003
4	Reverse osmosis membrane	
	Membrane service kit, type HR (High Rejection)	150718900-SP
	Membrane service kit, type HF (High Flow)	150718901-SP

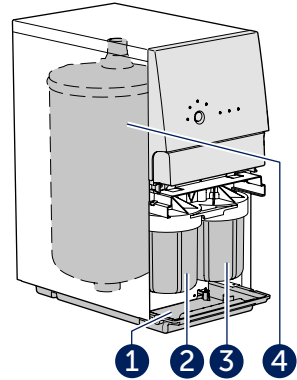

Figure 2. Pro inside

Control panel



For information about combinations of lights that flashes or are on, see "Troubleshooting" on page 49.

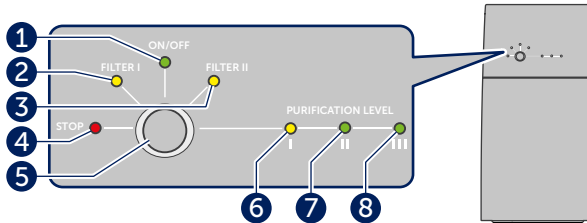

Figure 3. Control panel

Pos	Light/button	Description
1	ON/OFF	On: ● Off: ○ Flash: ●● The water purifier is connected to power. The water purifier is not connected to power. The water purifier is flushing.
2	FILTER I	On: ● Pro 400: Replace FILTER I. Pro 600: Replace both FILTER I and II.
3	FILTER II	On: ● Pro 400: Replace FILTER II. Pro 600: Replace both FILTER I and II.
4	STOP	Flashes/●●: Something is wrong, see "Troubleshooting" on pages 49-50.
5	Button	Various functions
6	PURIFICATION LEVEL I	On: ● Incomplete purification: DO NOT DRINK.
7	PURIFICATION LEVEL II	On: ● Medium purification: Ready to drink.
8	PURIFICATION LEVEL III	On: ● Highest purification: Ready to drink.

Data plate

The data plate is located on the rear side of the water purifier.

If you need service support, be sure to have the following data plate information available when calling your Bluewater dealer:

Data plate information:
–Model
–Product number
–Serial number

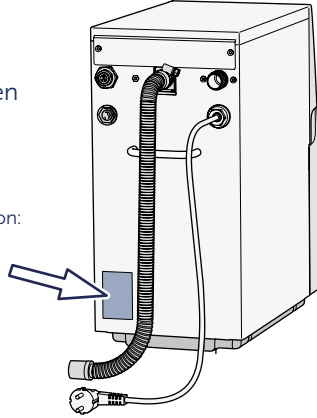

Figure 4. Data plate

Move the water purifier



Always transport the water purifier upright.
Install according to "Installation" on page 14.



Put the water purifier into storage using the preserving agent if Pro is disconnected from the water or electricity for >5 days. See "Put into storage" on pages 41-43.



Contact your Bluewater dealer for advice before relocating Pro to another geographical location or changing the source of the inlet water supply.

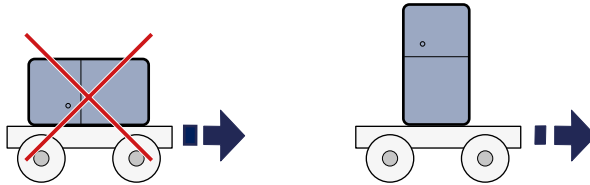

Figure 5. Move the water purifier

SYSTEM OVERVIEW

System description

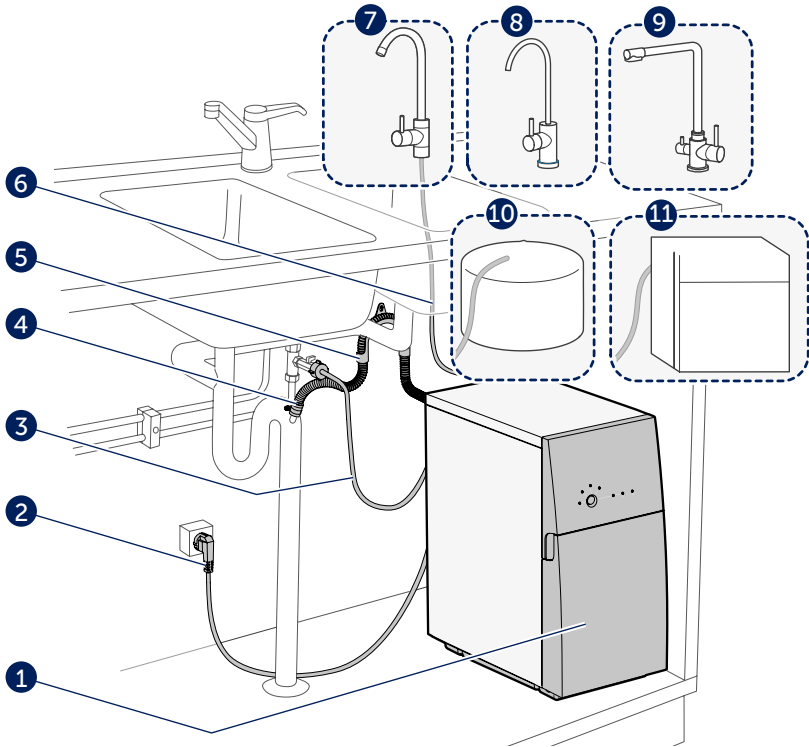

Figure 6. System overview, an example of Pro installation

Pos	Description	Pos	Description
1	Water purifier.	4	Drain water hose, installed with air gap.
2	Power cord.	5	Bracket for drain water hose.
3	Inlet water tube.	6	Purified water tube.

Pos	Accessories	Description
7	Standard RO faucet	Approved for use with Reverse Osmosis purified water.
8	Bluewater LED faucet	LED indicates service and purified water quality notifications.
9	Bluewater Triflow faucet	Provides purified water in addition to hot and cold non purified water.
10	Storage tank	Use only tanks approved for use with Reverse Osmosis purified water.
11	Appliance	Dishwasher, coffee machine, ice maker, refrigerator, etc. Appliances must be approved for use with Reverse Osmosis purified water.

Leak protection system

A sensor at the bottom of the water purifier senses water leaks. If there is a leak, the inlet water supply is stopped. The water purifier cannot be started again until the leak has been repaired.

Low pressure protection

 If Pro stops because of low inlet water pressure, the cause of the low inlet pressure must be resolved.

Low pressure restart function

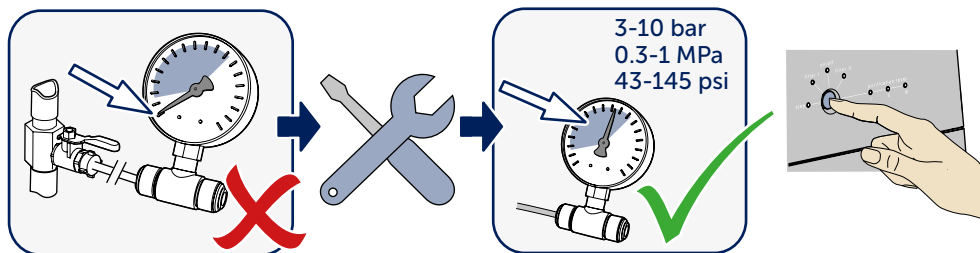

Figure 7. Low pressure restart function

The low pressure restart is a function to ensure maximum availability of inlet supply water.

If Pro has stopped due to low inlet water pressure, Pro attempts to restart automatically and continues restart attempts every 5 minutes, for up to 10 times. If the low inlet pressure problem is not resolved by the 10th restart attempt, Pro will stop.

Once the low inlet pressure has been resolved, Pro can be restarted manually by pressing the Button for 3 seconds.

Water production



Be aware! Do not use or drink the water before "PURIFICATION LEVEL II or LEVEL III" light turns green. It can take up to 60 seconds before the water purifier indicates good water quality.

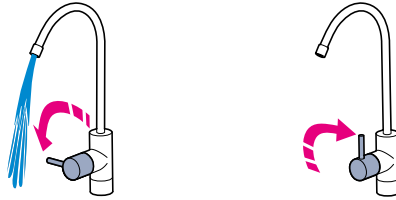

Figure 8. Water production on/off

Automatic flush



The length of the flush process varies between 5 to 120 seconds, depending on the quantity of purified water that has been produced.

An automatic flush will be performed if one of the conditions below is met:

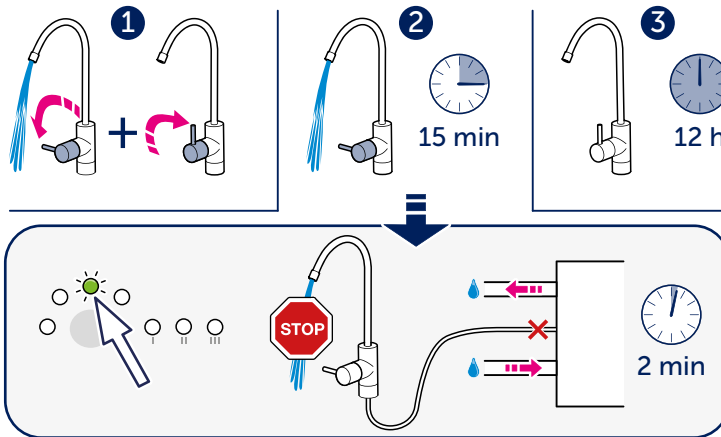

Figure 9. Automatic flush

Pos	Description
1	Automatic flush takes place after every use.
2	Automatic flush takes place after 15 minutes of total operation time. Purified water is not available during the 2 minute flush.
3	Automatic maintenance flush takes place every 12 hours when Pro is connected to water and power and is in Standby mode.

INSTALLATION



We recommend only approved technicians, distributors, or Bluewater service personnel perform the installation of the water purifier. Contact your Bluewater dealer if you have questions.



Installation of the water purifier must comply with all applicable local plumbing codes and regulations. Plumbing must be done by an approved plumber. Contact your Bluewater dealer if you have questions. Bluewater, as the manufacturer, has no responsibility for water purifier installations.



Only connect the water purifier to the cold water supply. The inlet water must be of sufficient quality and fulfil the requirements for inlet water. See “REQUIREMENTS FOR INLET WATER to water purifier” on pages 45-46.



Install the water purifier in a vertical position on a horizontal surface. Make sure that hoses, tubing, and electrical cords can move freely when the water purifier is installed.



Pro must supply purified water directly to a faucet or storage tank designed for reverse osmosis purified water. The purified water must not travel through any non approved pipes or faucets because this can cause corrosion damage.



The first time Pro is connected to water and power, the INSTALLER MUST initiate “Commissioning flush” on pages 19-24. This 54 minute flush is a VERY IMPORTANT flush and must be allowed to continue to completion. Keep Pro connected to power, with the purified water faucet open for the entire time. Do not interrupt this flush. Do not drink the water until this flush is complete.



Use the hose set that is supplied with the water purifier. Do not use used hose sets again.

Unpack Pro



Warning! Discard the packing material. It can cause injury to children if they play with it.



80% of the water purifier components and packaging are labeled to help you recycle and discard correctly.



Make sure that Pro shows no signs of damage and that no accessories are missing. Contact your Bluewater dealer about missing parts, damage, and other problems. Contact the shipping company immediately if Pro was damaged during transport.

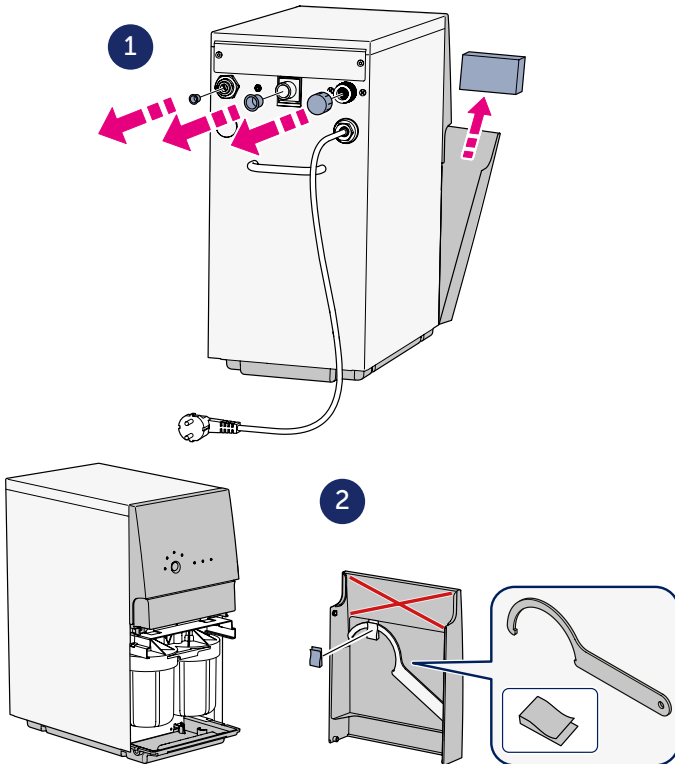

Figure 10. Unpack Pro

Position Pro



Put Pro in a vertical position, on a horizontal surface below the kitchen sink. Make sure that the surface can support the water purifier.

Position Pro near the cold water supply, the drain, and an earthed/grounded electrical supply.

- Make sure that it is easy to see the Control panel.
- Make sure that the front cover can be opened to access the filters.
- Hoses, tubing, and electrical cords can go in all directions from their connection points. Make sure that nothing can impede their free movement, or crush or damage them.

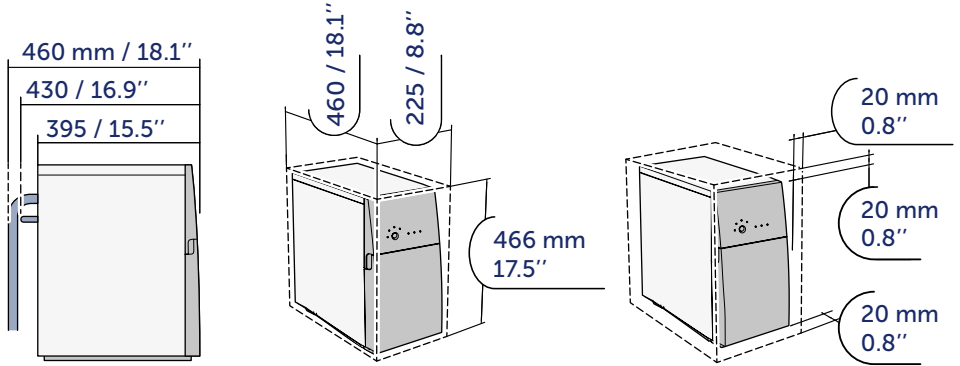

Figure 11. Position Pro

Install purified water faucet



In certain applications, the faucet may be replaced with a shutoff valve for supplying purified water to a storage tank or appliance. Shutoff valves, tubing, piping, storage tanks and appliances must be approved for use with reverse osmosis purified water.

Install the faucet according to the manufacturer's instructions.

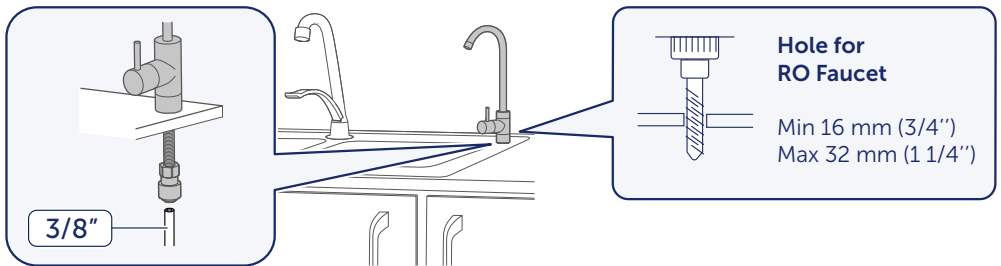

Figure 12. Install purified water faucet

Install inlet water connection



Only connect the water purifier to the cold water supply. The water must be of sufficient quality and meet the requirements for inlet water. See "REQUIREMENTS FOR INLET WATER to water purifier" on page 47-48.

The water purifier is connected to cold water via the inlet water tubing.

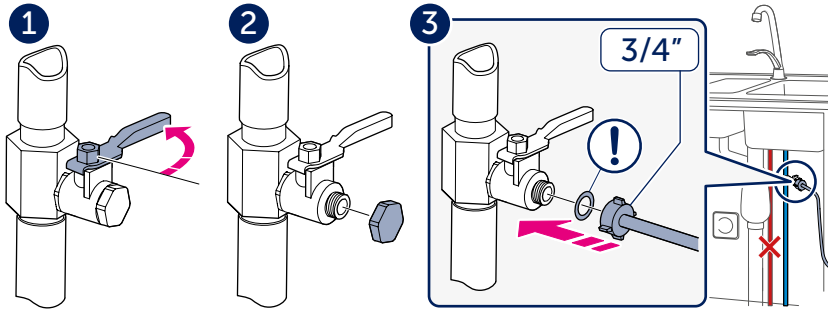

Figure 13. Install inlet water connection

Install drain water connection



Install the drain water hose with an air gap.



The flushed water goes through the drain water hose to the drain water outlet. The drain hose length should not exceed a maximum of four meters, and the internal diameter of the drain hose or tubing should not be reduced.

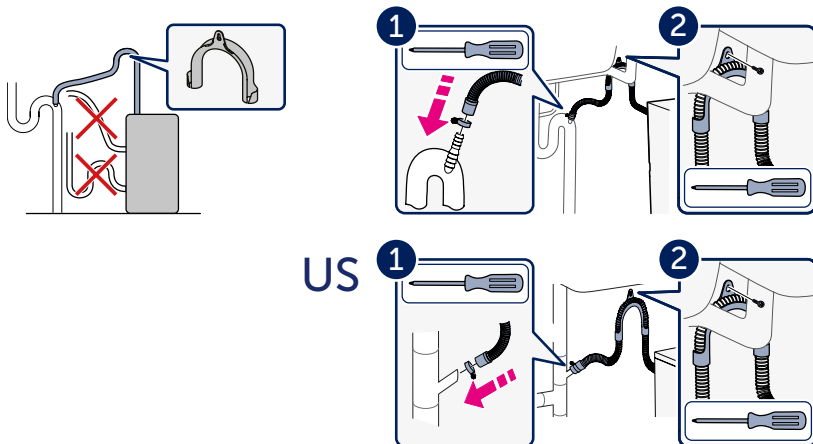

Figure 14. Install drain water connection

Connect the water purifier



-  During the initial setup, **ONLY** connect the water purifier to a faucet or shutoff valve. **DO NOT** connect the water purifier to storage tanks, appliances, or any other drinking water equipment until after the “Commissioning flush” procedure has been completed.
-  **DO NOT** connect the water purifier to electrical power at this time.

Figure 15. Connect the water purifier



Stop a “Commissioning flush” must be initiated!

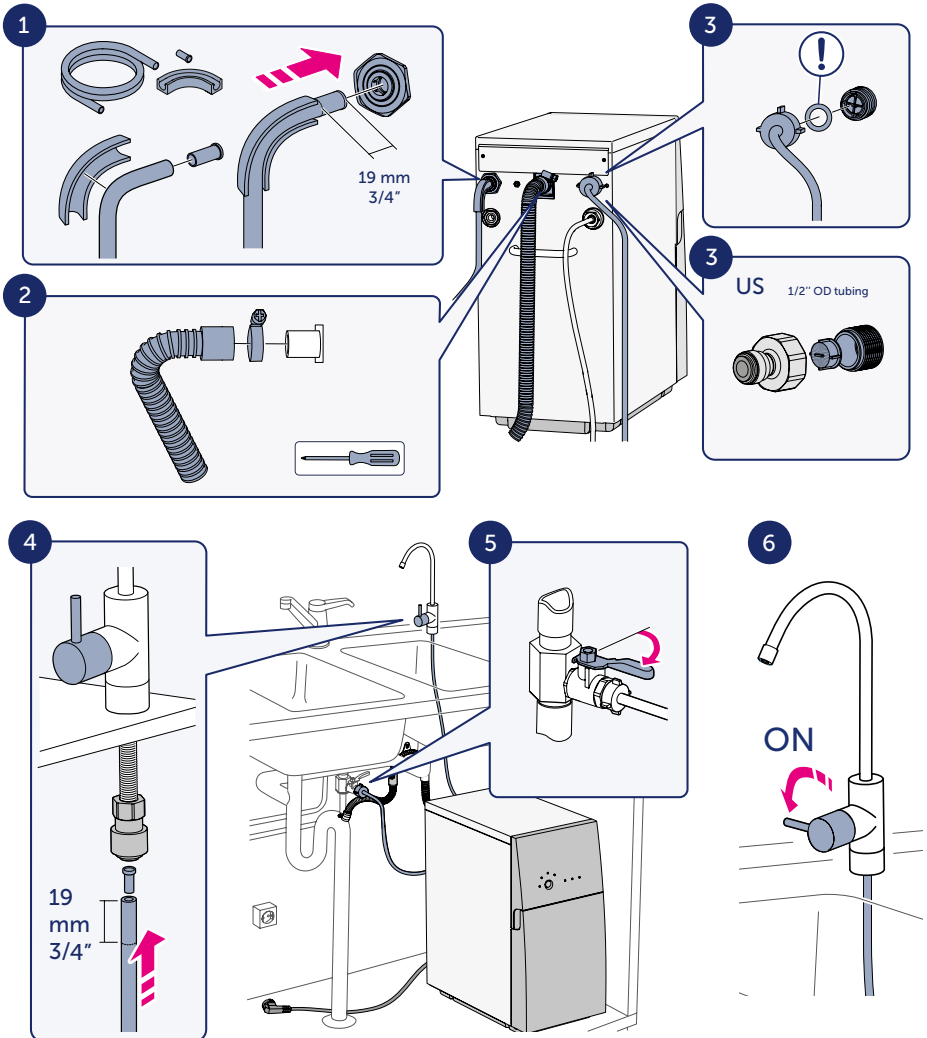

Before connecting Pro to any drinking water storage tanks, appliances, or equipment, the INSTALLER MUST initiate a first time “Commissioning flush”.



DO NOT use or drink the water until the 54 minute “Commissioning flush” has been completed. See “Commissioning flush” on pages 19-24.

Commissioning flush



A “Commissioning flush” MUST be performed when the water purifier is first installed, whenever a reverse osmosis membrane is replaced, or whenever Pro has been relocated to another geographical location or a different inlet water supply source is used.



This VERY IMPORTANT 54 minute “Commissioning flush” must be allowed to continue to completion.



DO NOT interrupt this flush.



DO NOT DRINK or use the water until this flush is completed.



Pro MUST NOT be connected to any water storage tanks, appliances, or any other drinking water equipment during this flush. All drinking water equipment must be disconnected, except a faucet or shutoff valve, until the “Commissioning flush” is completed.

“Commissioning flush” instructions, proceed with steps 1-12 as follows:

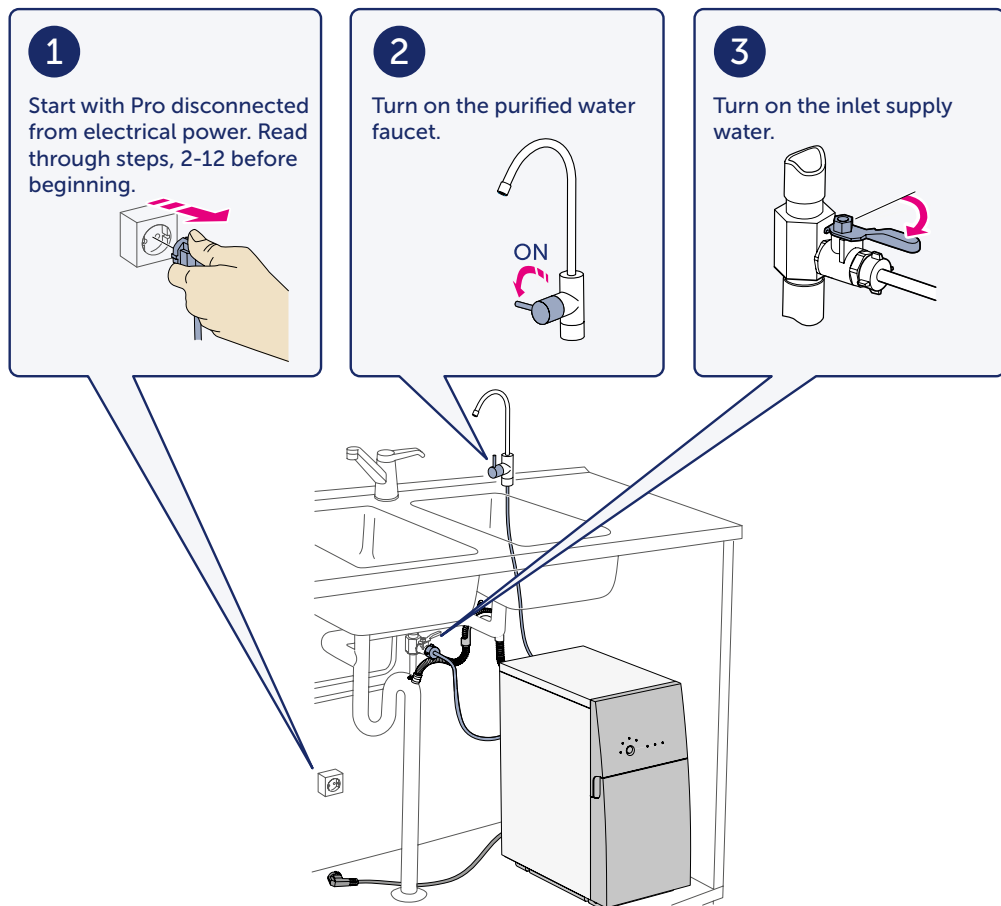
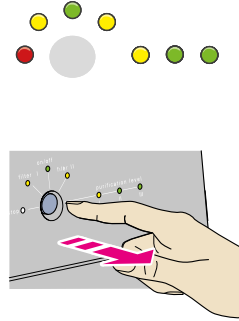
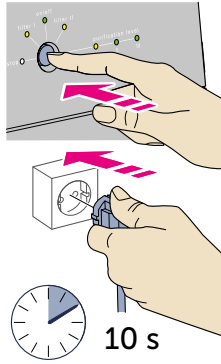

Figure 16. Commissioning flush

4



Press and hold the Control panel Button while plugging Pro into an electrical outlet. Keep the Button pressed for about 10 seconds.

Release the Button when all lights are on.

Figure 17. Commissioning flush

Once step 4 is completed, you will have 1 minute to initiate step 5; if step 5 is not initiated within 1 minute, the "Commissioning flush" setup procedure will be aborted.

If the Standby ON/OFF light appears, the procedure has been aborted. If aborted, turn off the water faucet, unplug Pro from power and start again at step 1. DO NOT use or drink the water until the "Commissioning flush" is run to completion, to step 12.



5

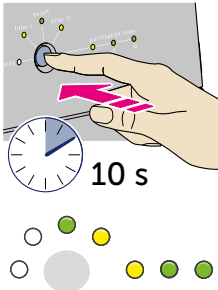

Again, press and hold the Control panel Button for 10 seconds.

Release the Button when these lights appear.



Figure 18. Commissioning flush

Once step 5 is completed, you will have 1 minute to initiate step 6; if step 6 is not initiated within 1 minute, the "Commissioning flush" setup procedure will be aborted.

If the Standby ON/OFF light appears, the procedure has been aborted. If aborted, turn off the water faucet, unplug Pro from power and start again at step 1. DO NOT use or drink the water until the "Commissioning flush" is run to completion, to step 12.



6

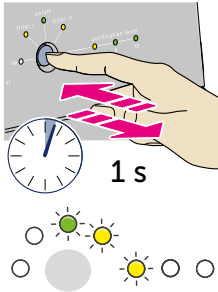

Press and release the Control Panel Button.

After the button is released these lights will appear.

Figure 19. Commissioning flush

Once step 6 is completed, you will have 1 minute to initiate step 7; if step 7 is not initiated within 1 minute, the “Commissioning flush” setup procedure will be aborted.

If the Standby ON/OFF light appears, the procedure has been aborted. If aborted, turn off the water faucet, unplug Pro from power and start again at step 1. DO NOT use or drink the water until the “Commissioning flush” is run to completion, to step 12.



7

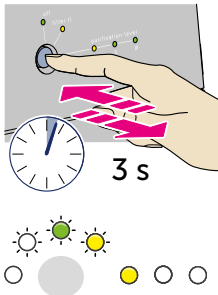

Press and hold the Control panel Button for 3 seconds.

Release the Button when these lights appear.

Figure 20. Commissioning flush

8 Wait, the "Commissioning flush" will start and run for 54 minutes.

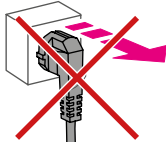
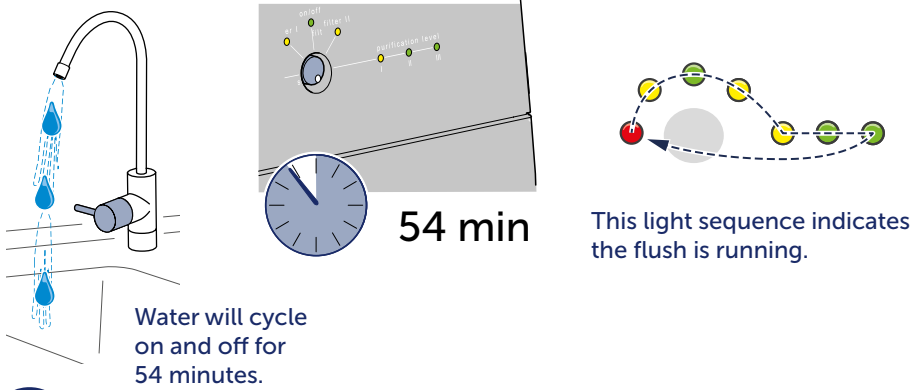

DO NOT DRINK!
DO NOT UNPLUG!

Figure 21. Commissioning flush



In case of a leak or if Pro must be left unattended, stop the flush and follow the EMERGENCY STOP procedure and restart procedure below.



"COMMISSIONING FLUSH" EMERGENCY



To STOP the "Commissioning flush":

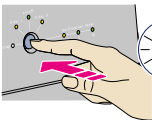

10 s

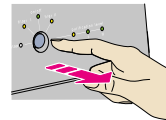

- Press and hold the Control panel Button for 10 seconds.
- When only the Standby ON/OFF light appears, release the Button.
- Turn off the faucet.
- Unplug Pro from power to prevent use!
- DO NOT use or drink the water until the flush has been restarted and completed. To restart the 54 minute "Commissioning flush", go back to step 1.

9

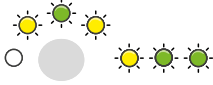
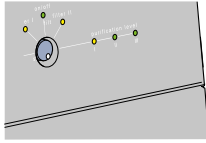

After the 54 minute flush, this light sequence appears.

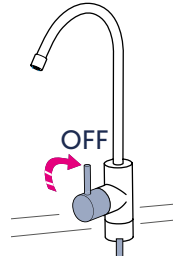

When these flashing lights appear, turn off the faucet.

Figure 22. Commissioning flush

10

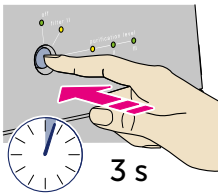

Press and hold the Control panel Button for 3 seconds.

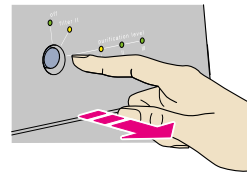
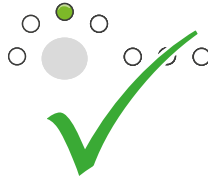

When the Standby ON/OFF light appears, release the Button. The "Commissioning Flush" is complete. Proceed to steps 11 and 12.

Figure 23. Commissioning flush

11

Drinking water equipment such as reverse osmosis approved storage tanks and appliances can now be connected to the water purifier.

Bluewater recommends any newly connected drinking water equipment and tubing be thoroughly rinsed with the purified water before using.

12 Do a check for leaks

⚠ The hose connections must be tight! Check all hose, tubing, valve, faucet, and drinking water equipment connections. If there are any leaks, see "Repair leaks" on page 25.

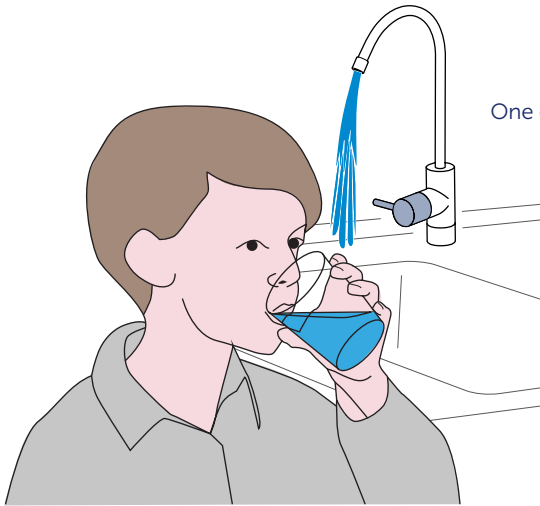
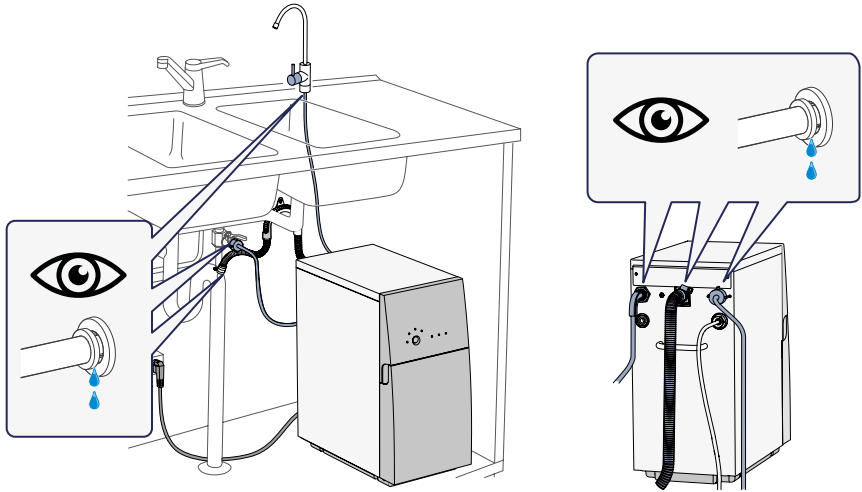

Enjoy your **BLUEWATER PRO!**
One of the best water purifiers in the world!

Figure 24. Commissioning flush

MAINTENANCE

Daily maintenance: Check indicator lights

Step	Action
1	Check that only the ON/OFF light is on, and no other lights are on or flashing while Pro is in Standby mode. If any other lights are on or flashing, see "Troubleshooting" on page 47-48.

Weekly maintenance: Clean the water purifier



Do not use chemicals to clean the surface. Alcohol, petrol, organic and inorganic acids, strong basic chemicals (such as concentrated dishwashing detergent) will cause damage to the surface.



Do not use hard, sharp, or abrasive tools to clean the water purifier.

Step	Action
1	Clean the outer surface with a soft, moist cloth and a weak soap solution to remove dust, stains, and dirt.
2	Dry with a soft dry cloth.

Regular maintenance



Regular maintenance is important for correct function and long term operation. Only authorized technicians, distributors, or dealers approved by Bluewater can perform maintenance and repairs.



If the inlet supply water or purified water quality changes, see "Test the water" on page 36 and contact your Bluewater dealer.



Do not drink the water when the water purifier flushes, or when you do maintenance with chemicals. It is not safe to use.



The inlet supply water quality controls the maintenance frequency. If the inlet supply water is of low quality, do maintenance more frequently. See "REQUIREMENTS FOR INLET WATER to water purifier" on pages 47-48.

Frequency	Action
1 month	Check connections for leaks, page 25 .
	Wipe off condensation from the base plate, page 28 .
4-6 months*	Replace the filters every 4-6 months, or as indicated by the FILTER I and FILTER II LED indicator lights, page 28 .
6 months*	Descalc, pages 31-34 .
6-12 months*	Clean Inlet Grid Filter, page 35 .
1 year	Test the purified water every year, page 36 . If the purified water is not clean, do not drink it. Contact a Bluewater dealer.
4-6 years*	Replace reverse osmosis membrane. Contact your Bluewater dealer.
*Frequency depending on inlet water quality and usage.	

Each month

Do a check for leaks

See "Do a check for leaks" [on page 25](#).



If the inlet supply water or purified water quality changes, see "Test the water" [on page 34](#) and contact your Bluewater dealer.

Repair leaks

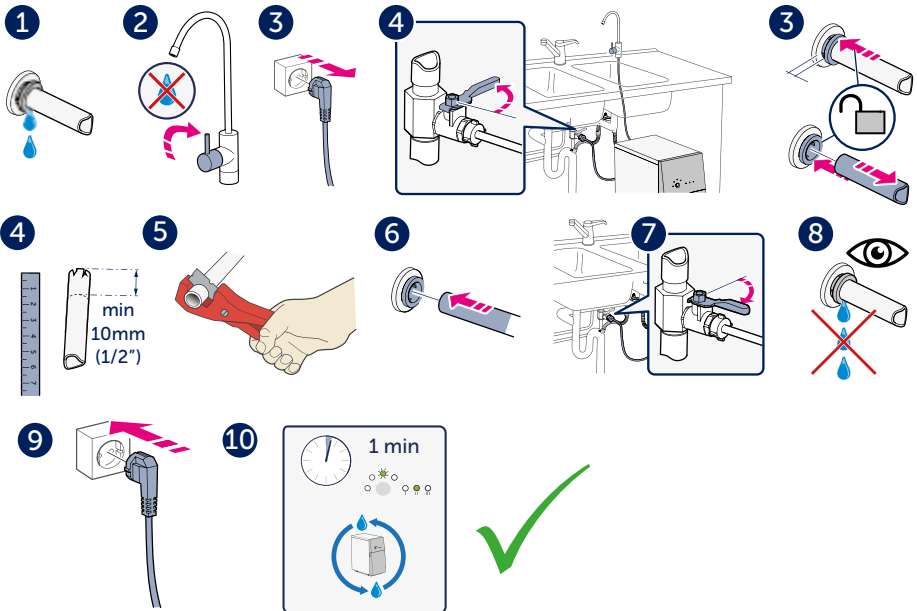

Figure 25. Repair leaks

Wipe off condensation from base plate

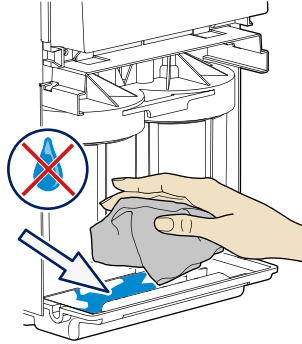

Figure 26. Wipe off condensation from base plate

Each 4-6 months Replace filters



We recommend only approved technicians, distributors, or Bluewater service personnel perform servicing and repairs on the water purifier.



Pro 400:

Replace each filter every 4-6 months or replace each filter as indicated by the corresponding FILTER I or FILTER II light.



Pro 600:

Replace both filters at the same time every 4-6 months or replace both filters at the same time when either FILTER I or FILTER II lights up. Both filters should always be replaced together on Pro 600.



To order filters, contact your Bluewater dealer.

1

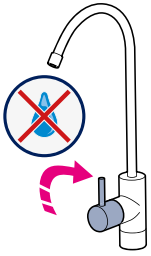

2

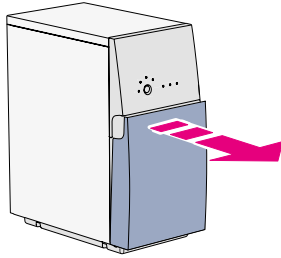

3

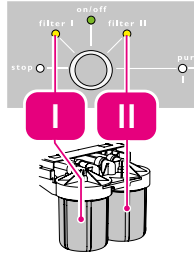

4

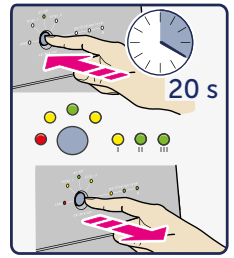

5

Pro400: I

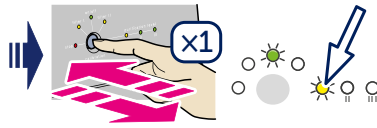

Pro400: II

Pro400: I + II

Pro600: I + II

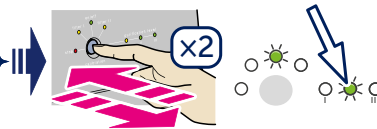

6

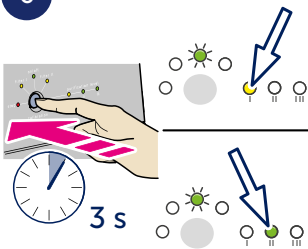

7

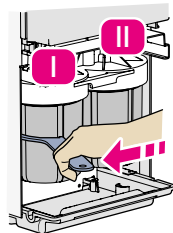

8

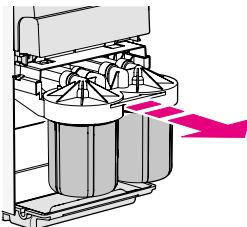

9

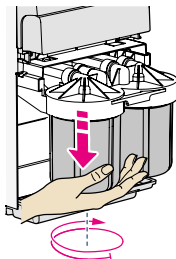

10

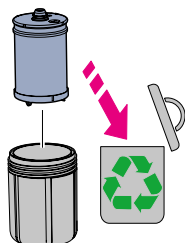

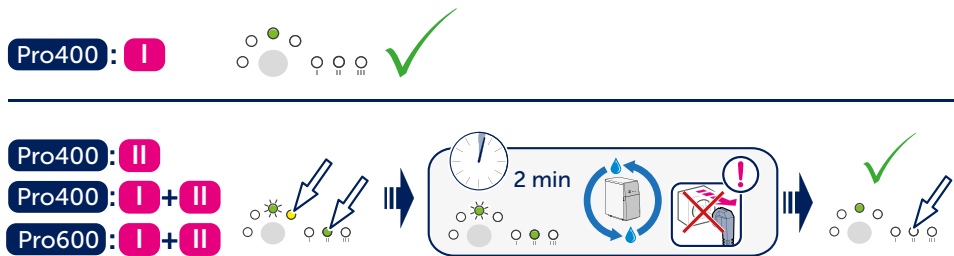
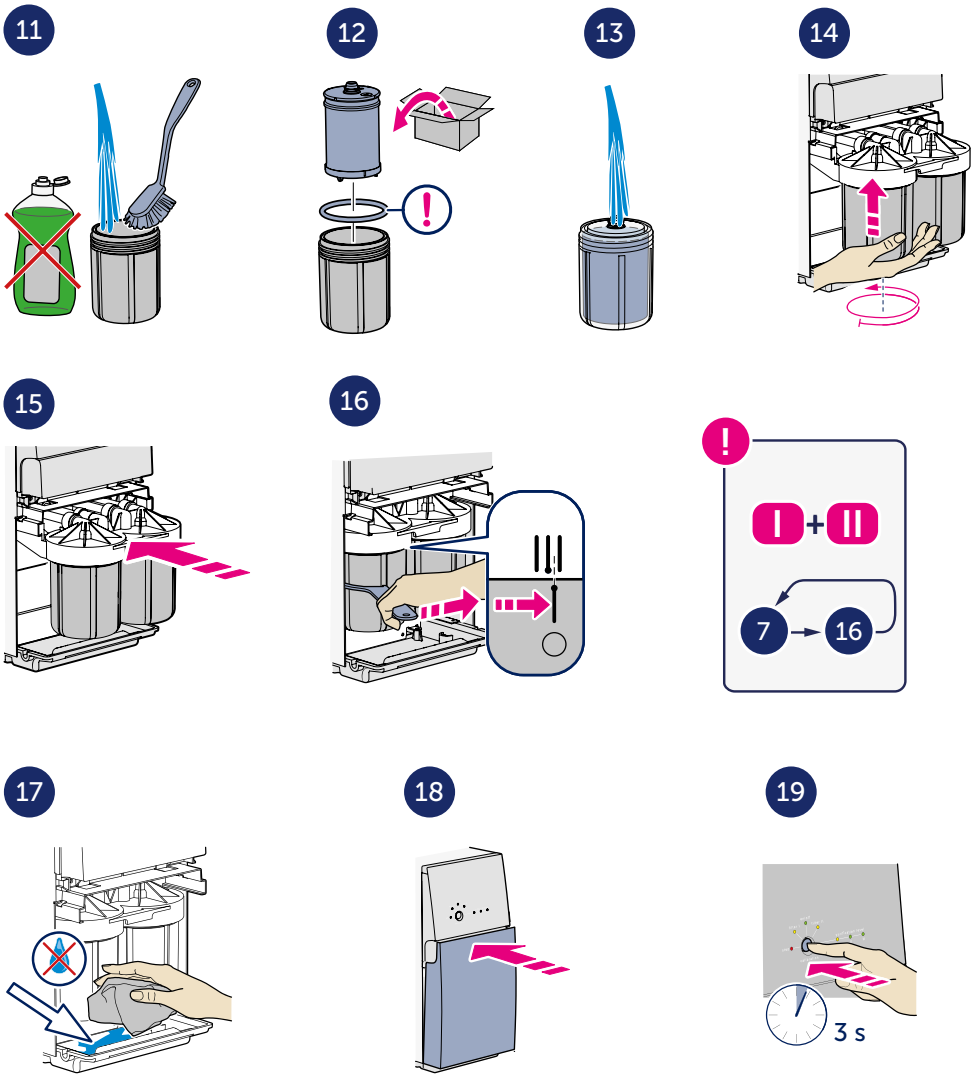

Figure 27. Replace filter

Each 4-6 months Descal



The descaling product can cause skin irritation. Keep the descaling product out of the reach of children.



When handling the descaling product, wear protective gloves and eye protection. Wash hands after using.



We recommend only approved technicians, distributors, or Bluewater service personnel perform servicing and repairs on the water purifier.



To order the descaling product, contact your Bluewater dealer.



Descaling frequency depends on the quality of the inlet supply water and usage!
To extend the water purifier lifetime: Descal Pro at 6 month intervals or when the purified water flow has decreased.



If Pro has been descaled and the filters have been replaced, but the purified water flow cannot be restored, contact your Bluewater dealer.



The descale takes approximately 10 hours. Do not use the water purifier during this time.

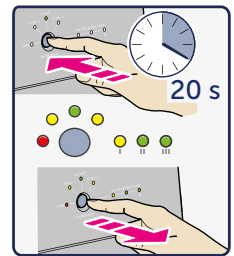
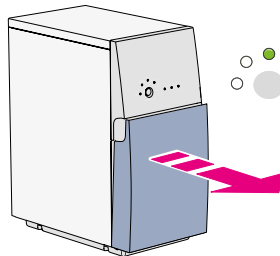
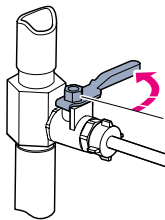
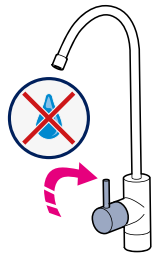

6

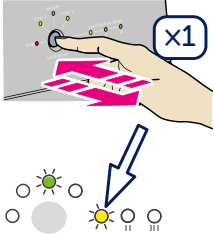

7

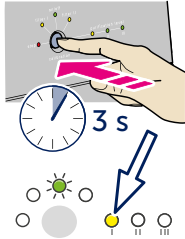

8

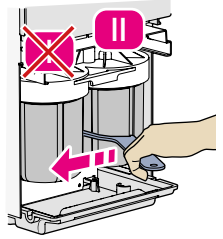

9

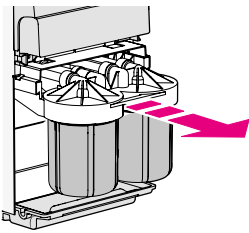

10

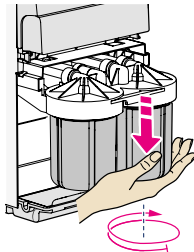

11

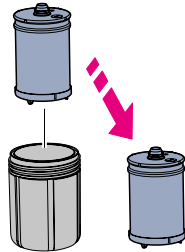

12

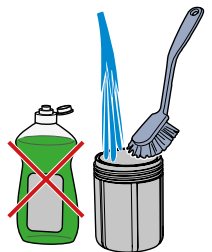

13



14



15



16

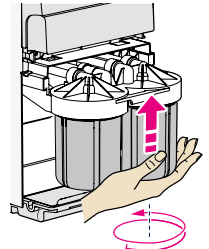

17

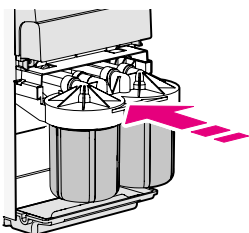

18

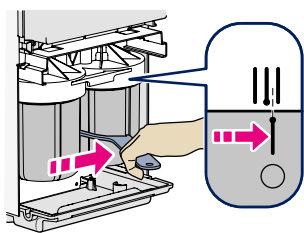

19

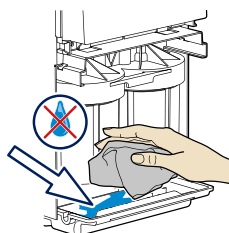

20

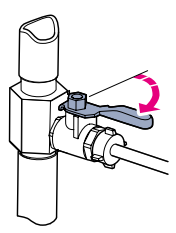

21

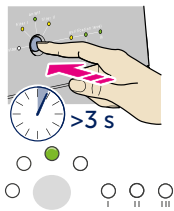

22

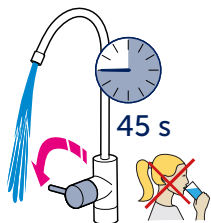

23

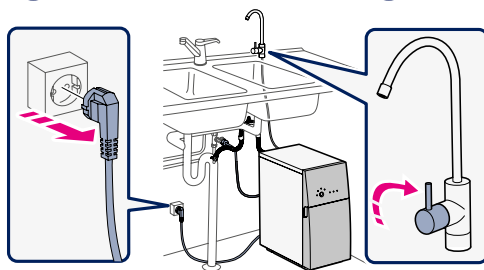

24

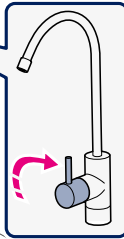

25

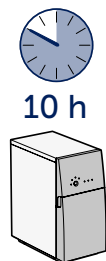

26

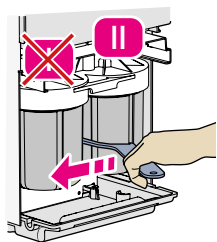

27

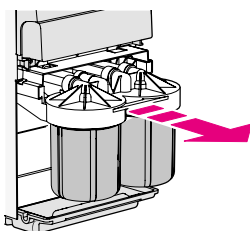

28

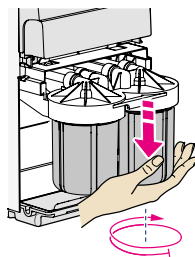

29

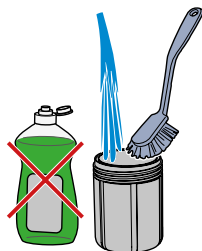

30

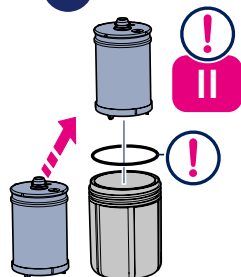

31



32

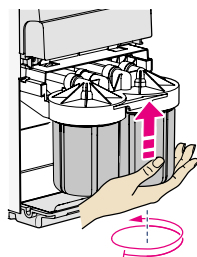

33

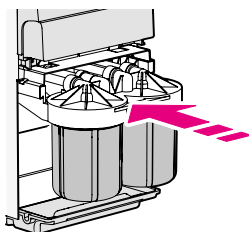

34

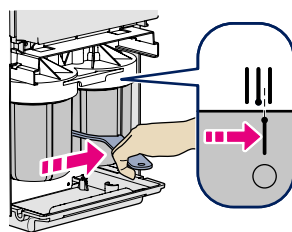

35

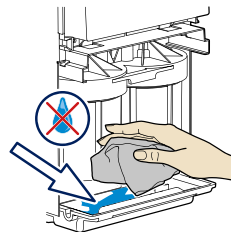

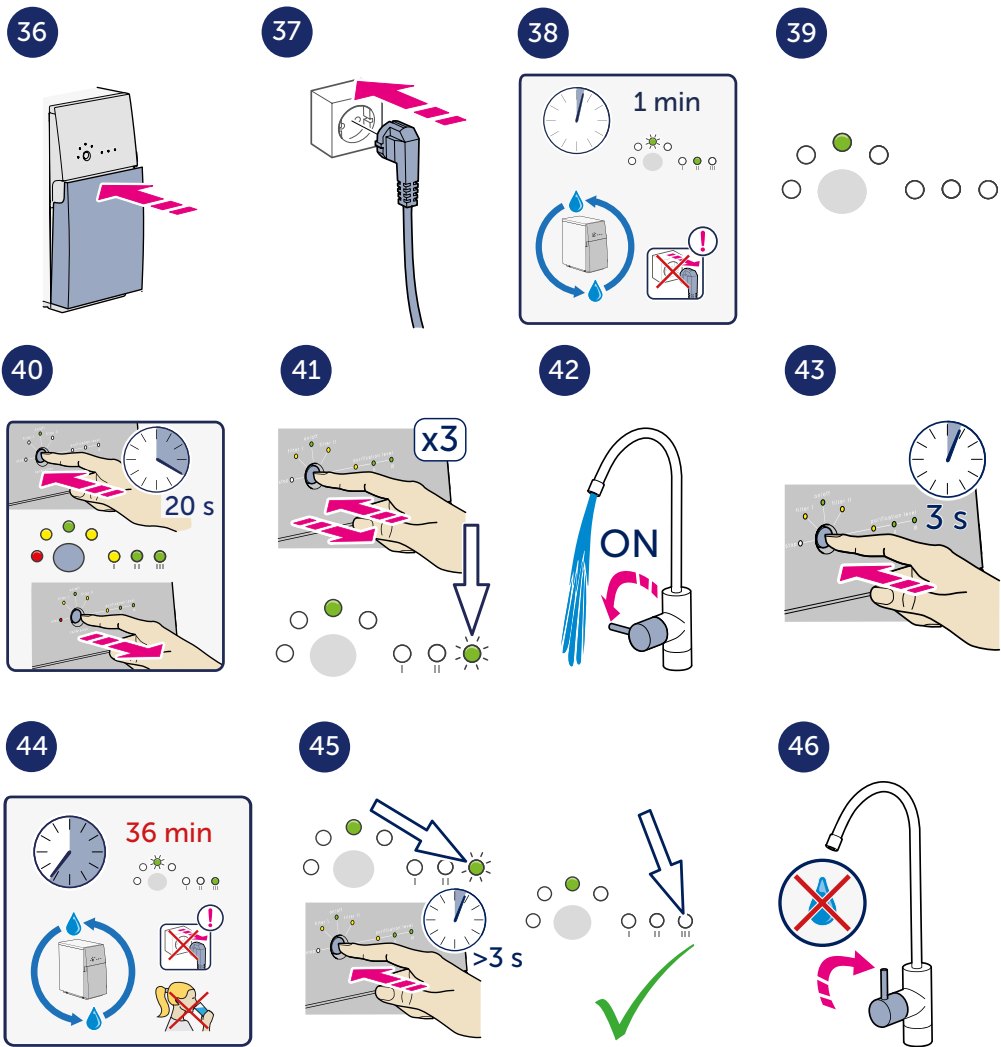

Figure 28. Descalce

Each 6-12 months

Clean the Inlet Grid Filter



The Inlet Grid Filter is in the inlet water connection and catches larger particles. If the purified water flow has decreased, if Pro becomes noisy, or if the FILTER I indicator light comes on, the Inlet Grid Filter may be blocked.



For more information about a blocked Inlet Grid Filter, see "Troubleshooting" on page 49-50.



Cleaning frequency depends on the quality of the inlet supply water.

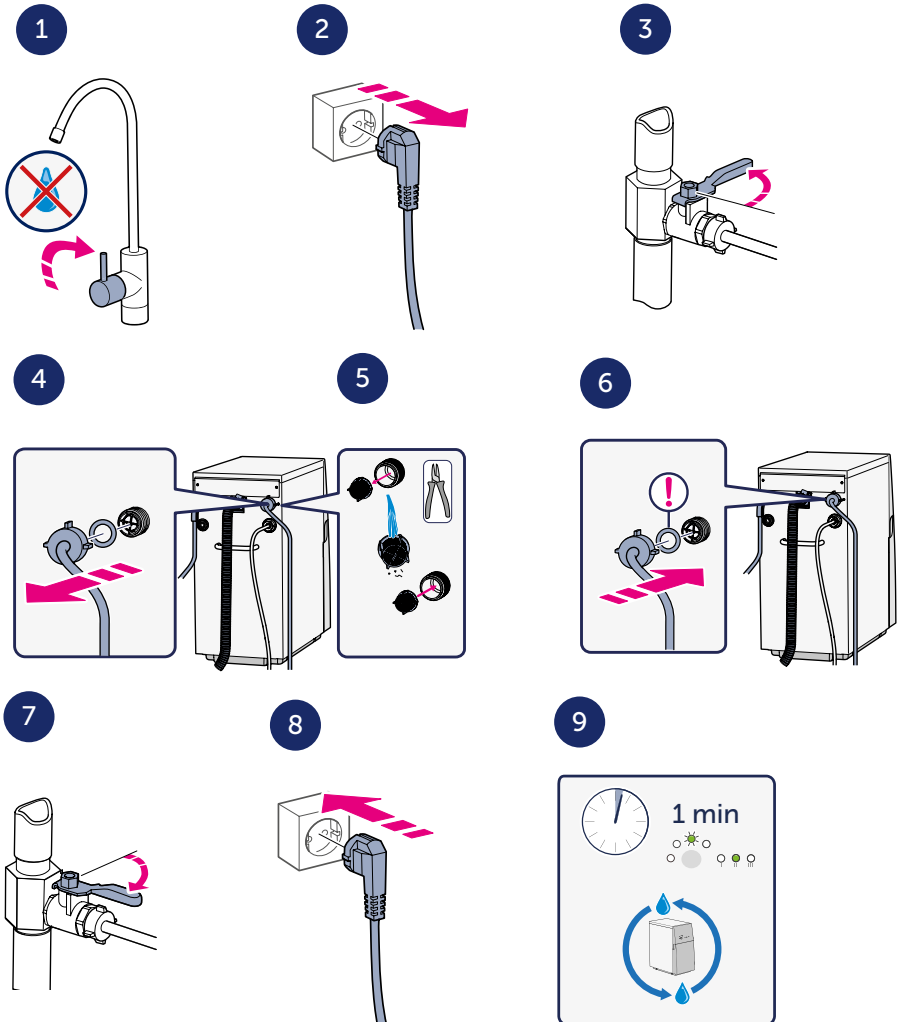

Figure 29. Clean the Grid Filter

Each year Test the water



Test the purified water periodically using a TDS/Conductivity tester at least one time every year to make sure that Pro performs correctly. For options, contact your Bluewater dealer.



If there is any indication that the purified water tastes or smells bad, is cloudy, or there is a presence of particles, do not drink. See “Use disinfectant to clean the system” [on page 37-40](#) and contact your Bluewater dealer.



Make sure inlet supply water meets requirements. See “REQUIREMENTS FOR INLET WATER to water purifier” [on page 47-48](#).

Other Flush Pro



We recommend only approved technicians, distributors, or Bluewater service personnel perform servicing and repairs on the water purifier.



DO NOT drink the water during the flush process. It is not safe to use or drink.







DO NOT interrupt this flush



The water purifier should always be flushed after the following procedures:

- When Pro has been disinfected. See “Use disinfectant to clean the system” [on pages 37-40](#).
- When Pro has been descaled. See “Descal” [on pages 31-34](#).
- When Pro has had the Reverse Osmosis membrane replaced. Contact your Bluewater dealer.
- When Pro is installed again after storage/freeze protection. See “Reinstall after storage” [on pages 43-46](#).
- When Pro has been relocated to another geographical location or a different inlet water supply source is used. See “Commissioning flush” [on pages 19-24](#).
- When Pro is installed for the first time. See “Commissioning flush” [on pages 19-24](#).

Use disinfectant to clean the system

-  Disinfectant product can be harmful. Keep the disinfectant product out of the reach of children.
-  If handling the disinfectant product, wear protective gloves and eye protection. Wash hands after using.
-  We recommend only approved technicians, distributors, or Bluewater service personnel perform servicing and repairs on the water purifier.
-  Use 25ml (1 oz) of a 3.5% sodium hypochlorite (NaClO) solution, as shown in the illustration below.

Household chlorine bleach contains sodium hypochlorite in various percentages, typically from 3 to 7.5%. Household chlorine bleach can be used in place of the 3.5% sodium hypochlorite solution if the amount of household bleach is adjusted to meet the 3.5% NaClO per 25ml (1 oz) dosage. For example: If the household bleach contains 7% sodium hypochlorite, then half the amount of the household bleach would be needed (12.5ml or 0.5 oz) to meet the dosage requirement. Contact your Bluewater dealer for advice.

-  Sodium hypochlorite (NaClO) or household chlorine bleach **MUST NOT CONTAIN** added color, fragrance, sudsing/foaming agents, or surfactants. Contact your Bluewater dealer for help finding the correct product.
-  Disinfect the water purifier when the water tastes or smells bad.

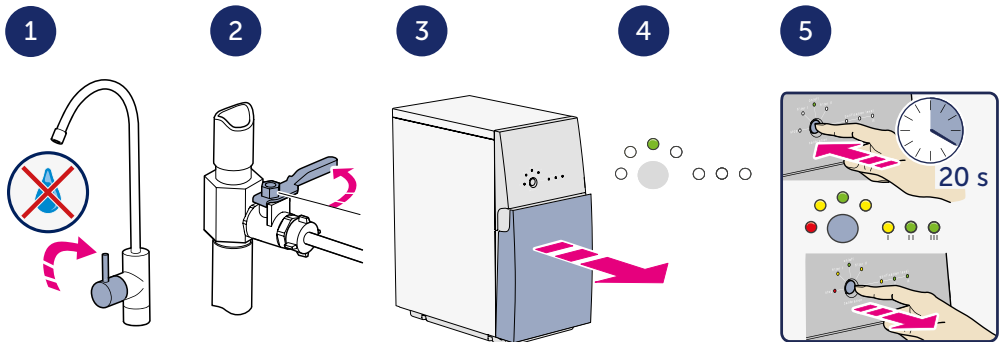

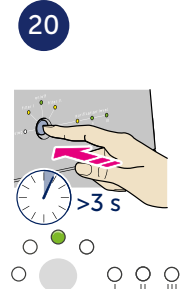
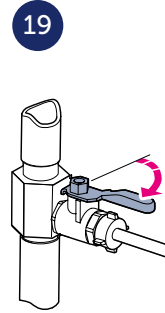
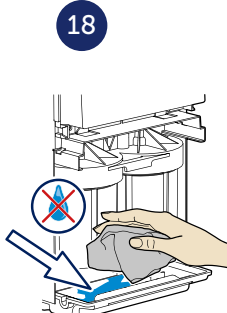
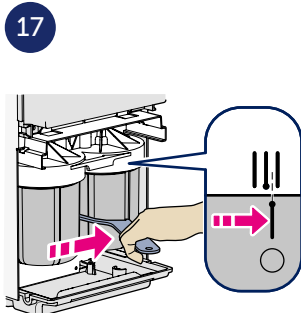
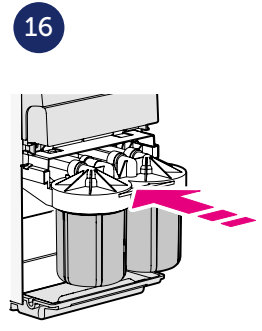
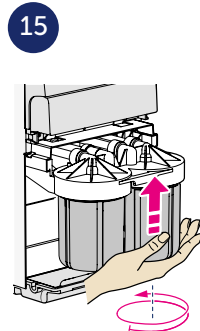
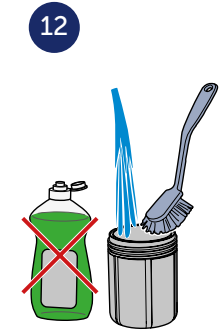
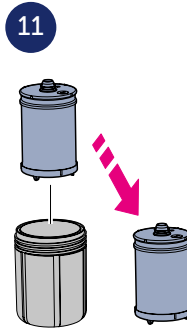
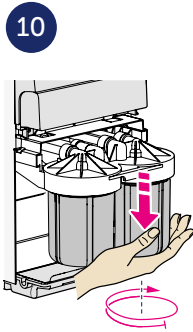
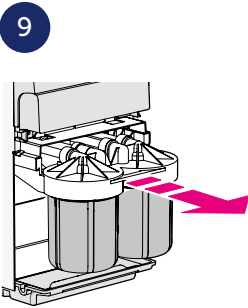
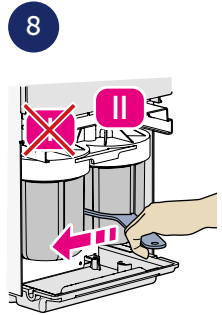
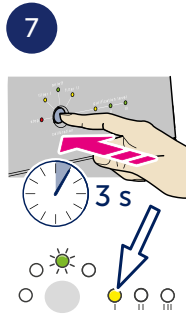
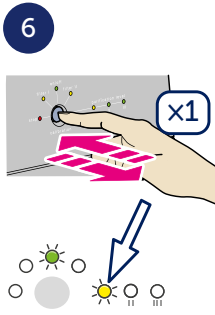

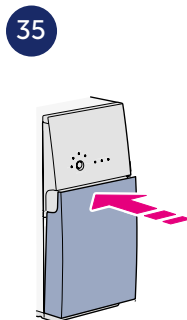
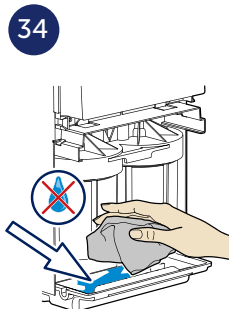
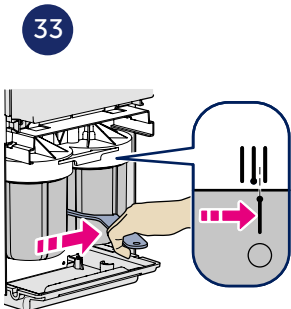
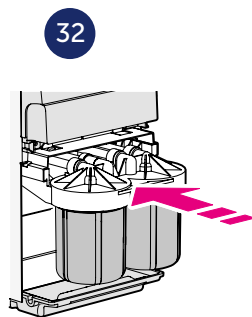
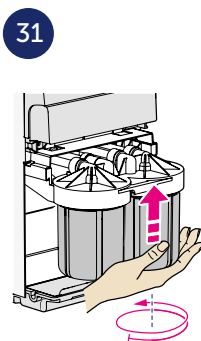
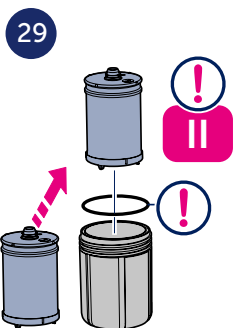
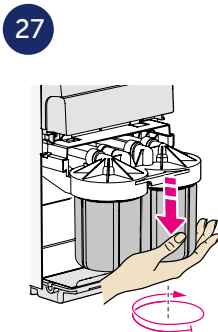
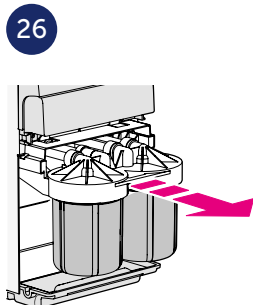
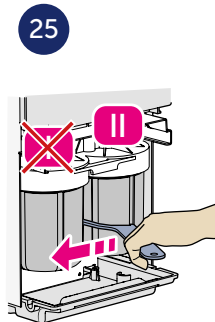
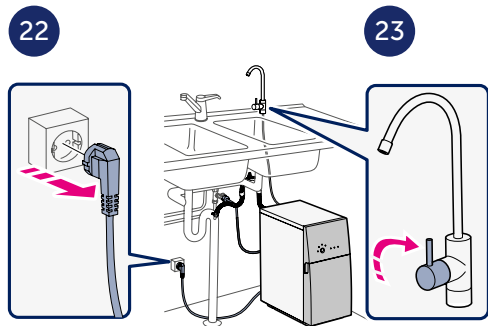

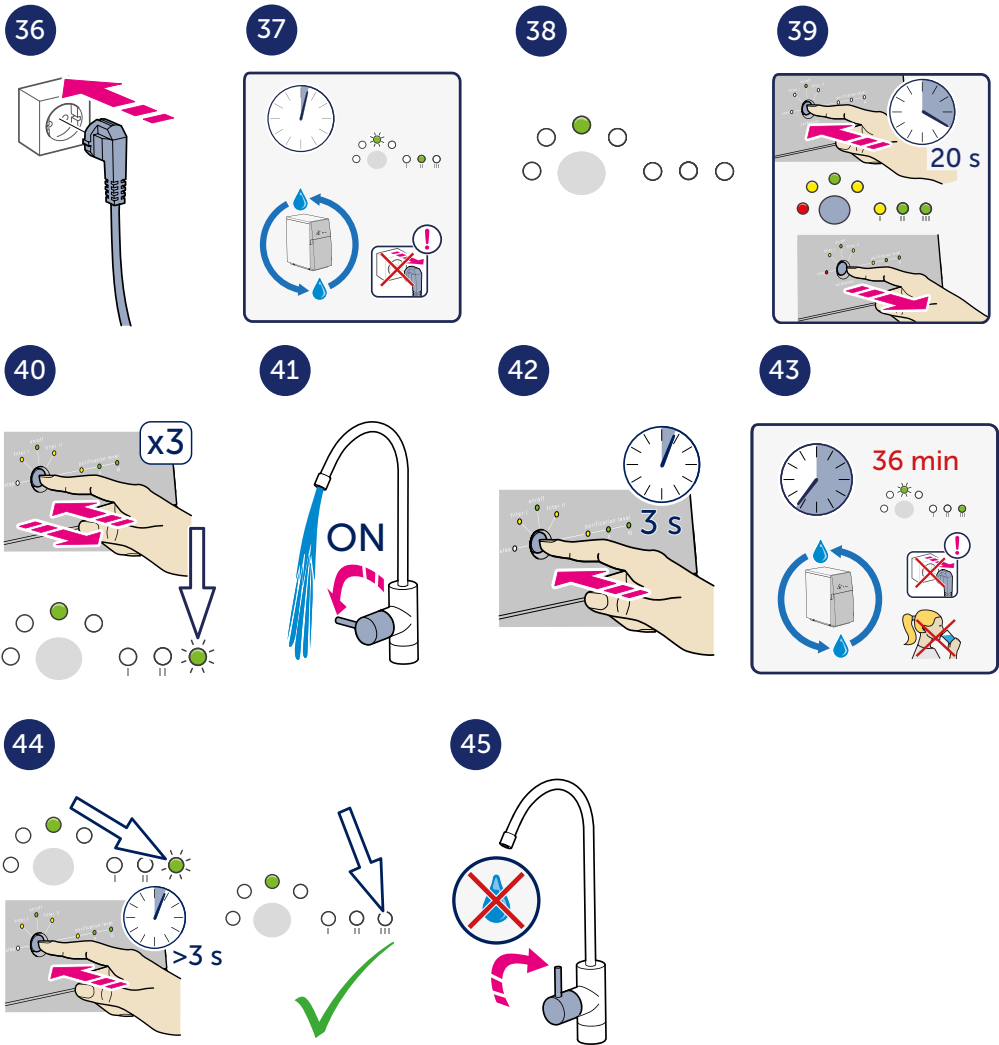

Figure 30. Use disinfectant to clean the system

Put into storage



We recommend only approved technicians, distributors, or Bluewater service personnel perform servicing and repairs on the water purifier.



Put the water purifier into storage using the preserving agent if Pro is disconnected from the water or electricity for >5 days. As long as Pro remains connected to water and electricity, it can be left unused with the purified water faucet off for an extended period of time. If Pro will not be used for 4 or more months, Bluewater recommends that the water purifier be put into storage using the preserving agent.



Preserving agent can cause skin irritation. Keep the preserving agent out of the reach of children.



When handling the preserving agent, wear protective gloves and eye protection. Wash hands after using.



To order the preserving agent, contact your Bluewater dealer.

1

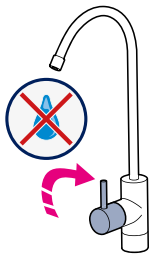

2

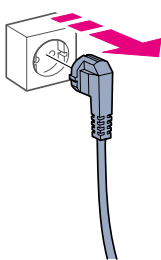

3

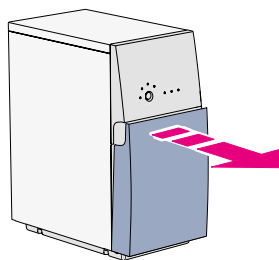

4

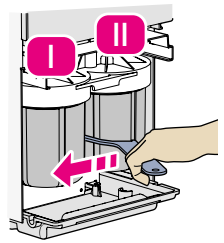

5

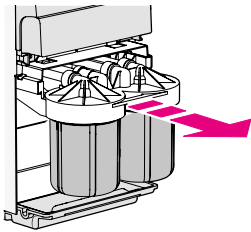

6

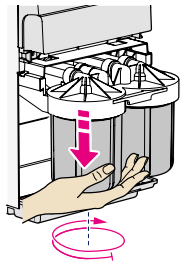

7

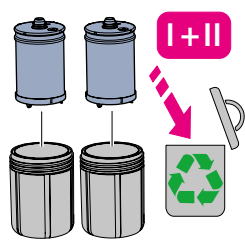

8

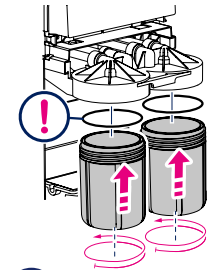

9

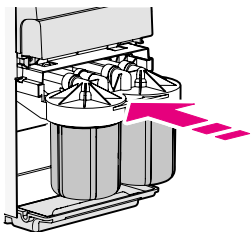

10

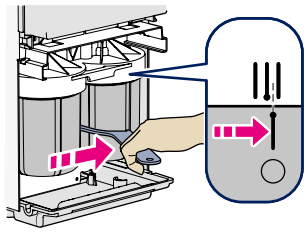

11

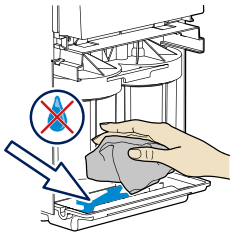

12



13

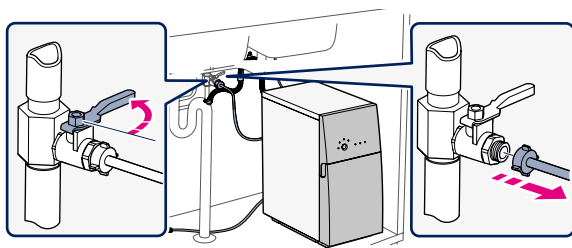

14

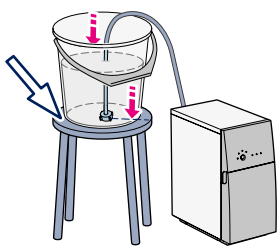

15

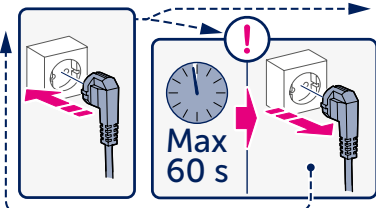

16

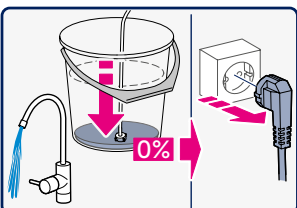

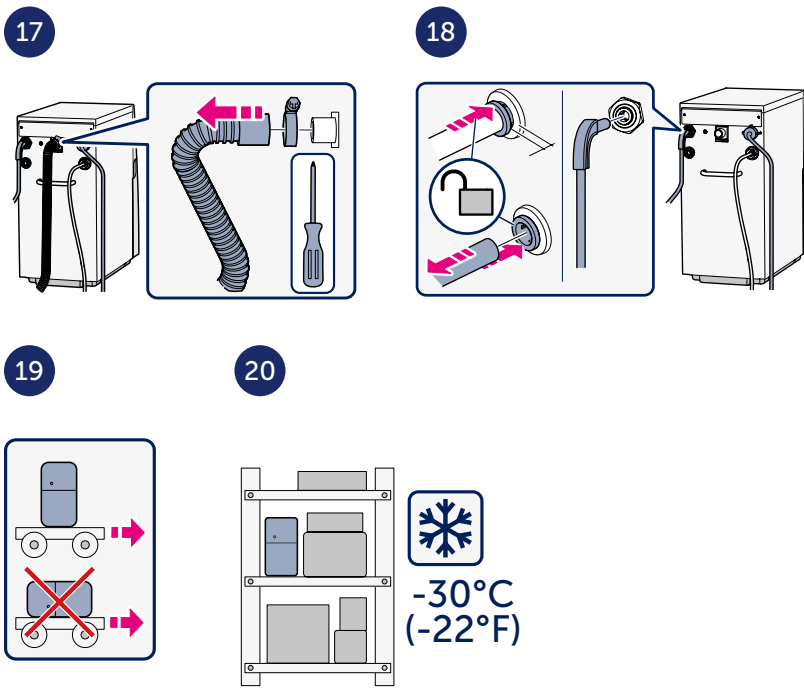



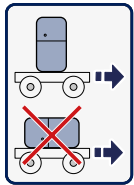

Figure 31. Put into storage

Reinstall after storage

-  Preserving agent can cause skin irritation. Keep the preserving agent out of the reach of children.
-  When handling the preserving agent, wear protective gloves and eye protection. Wash hands after using.
-  We recommend only approved technicians, distributors, or Bluewater service personnel perform servicing and repairs on the water purifier.

1



2

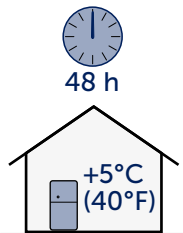

3

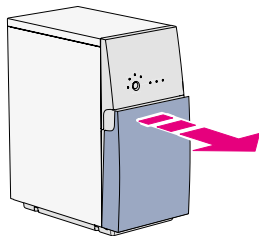

3

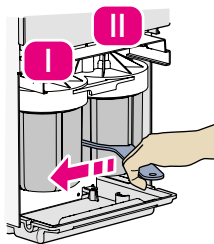

4

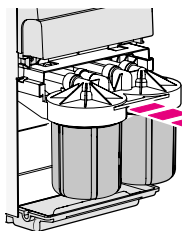

5

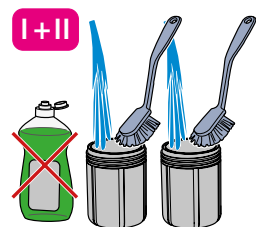

6

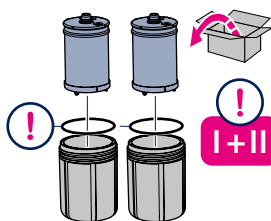

7

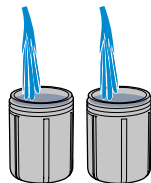

8

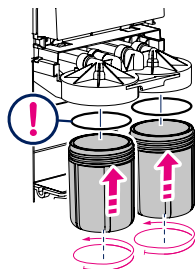

9

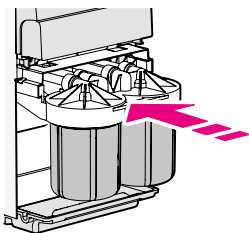

10

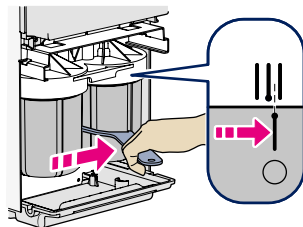

11

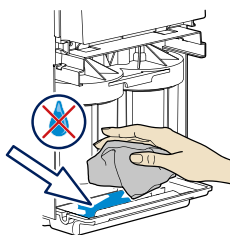

12

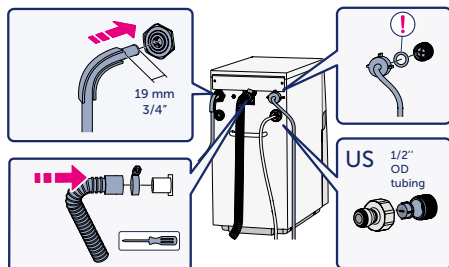

13

14

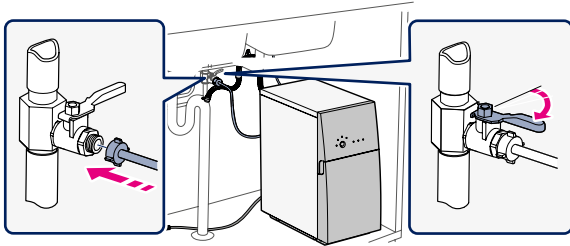

15

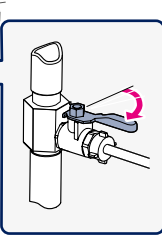

16

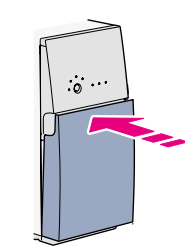

17

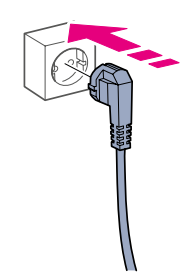

18

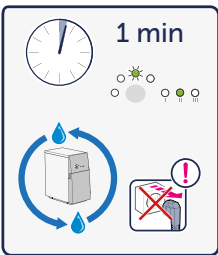

19

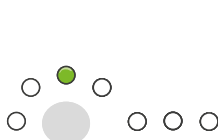

20

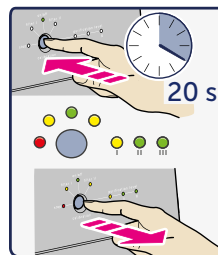

21

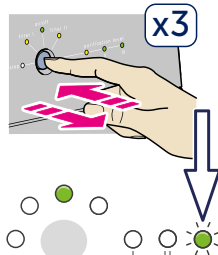

22



23

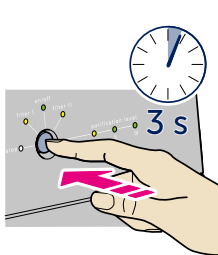

24

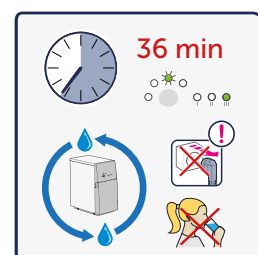

25

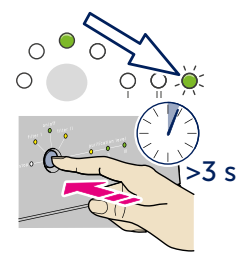

26

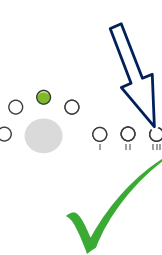

27

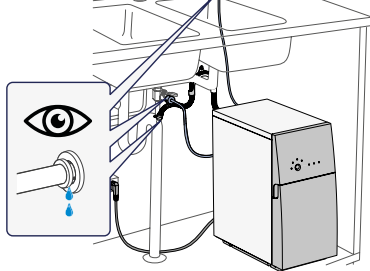

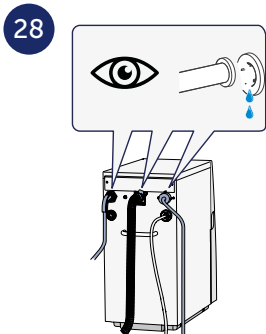

Figure 32. Reinstall after storage



See "Check for leaks [on page 25](#)."



TECHNICAL INFORMATION

Technical data

Model	Size WxHxD	Weight	Power	Power supply earthed/grounded	
Pro 400C-HF Pro 400C-HR Pro 400BC-HR	220-240V	225x466x460 mm	29 kg	530 W	220-240V, 50-60 Hz
Pro 400CV-HR Pro 400BCV-HR	120V	8.9x18.3x18.1 inches	64 lbs	6 Amp	120V, 60 Hz
Pro 600C-HF Pro 600CV-HR	220-240V	225x466x460 mm	29 kg	720 W	220-240V, 50-60 Hz

Model	On/Off [bar psi]	Membrane type	Filter	Operation sequence (production/flush) [minutes]
Pro 400C-HF	3/4.5 (44/65)	High flow	Particle Granulated carbon	15/2
Pro 400C-HR	3/4.5 (44/65)	High rejection	Particle Granulated carbon	15/2
Pro 400BC-HR	0.5/2 (7/29)	High rejection	Particle Granulated carbon	15/2
Pro 400CV-HR	3/4.5 (44/65)	High rejection	Particle Granulated carbon	15/2
Pro 400BCV-HR	0.5/2 (7/29)	High rejection	Particle Granulated carbon	15/2
Pro 600C-HF	3/4.5 (44/65)	High flow	Carbon block	15/2
Pro 600CV-HR	3/4.5 (44/65)	High rejection	Carbon block	15/2

Requirements for inlet water to water purifier

-  Do not use with inlet supply water that is microbiologically unsafe or of unknown quality without adequate disinfection before or after the system.
-  Only connect to the cold water supply. The temperature limits are in the table below.
-  If the inlet supply water quality changes, contact your Bluewater dealer.

	Pro 400BC-HR Pro 400BCV-HR		Pro 400C-HF Pro 400C-HR Pro 400CV-HR		Pro 600C-HF Pro 600CV-HR
	230V	120V	230V	120V	230V
Temperature	2-30 °C	36-86 °F	2-35 °C	36-95 °F	2-35 °C
Inlet water flowing pressure	3-10 bar 0.3-1 MPa	43-145 psi	3-10 bar 0.3-1 MPa	43-145 psi	3-10 bar 0.3-1 MPa
TDS/PPM (Total Dissolved Solids)	< 7500 ppm		< 1500 ppm		< 1500 ppm
Inlet water flow	> 8 l/min	> 2.1 gal/min	> 8 l/min	> 2.1 gal/min	> 10 l/min
Conductivity [µS/cm, @ 25 °C (77 °F)]	< 13 000		< 2000		< 2000
Hardness	< 20 °dH	<20.9 gpg	< 20 °dH	<20.9 gpg	< 20 °dH
pH	4-10		4-10		4-10
Turbidity (FNU)	< 0.5		< 0.5		< 0.5
Iron Fe (II) / Fe (III)	<1.5 / <0.3 mg/l	<1.5 / <0.3 ppm	<1.5 / <0.3 mg/l	<1.5 / <0.3 ppm	<1.0 / <0.3 mg/l
Manganese (Mn2+)	<0.3 mg/l	<0.3 ppm	<0.3 mg/l	<0.3 ppm	<0.3 mg/l
Chlorine Cl ₂	<1.0 mg/l	<1.0 ppm	<1.0 mg/l	<1.0 ppm	<1.0 mg/l
Minimum recommended inlet supply size: 0.5 inch OD Tubing or Pipe Minimum recommended inlet supply valve: 0.5 inch NPT or BSSP					





TROUBLESHOOTING

How to solve simple problems

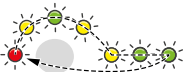

If Pro stops because of an emergency, disconnect it from power and connect it again, or press and hold the Button for 3 seconds to reset the emergency stop.

Symptom	Cause	Solution
	The ON/OFF light flashes.	The water purifier is flushing. Allow flush to be completed before using the water purifier.
	Pro 400: Replace FILTER I. Pro 600: Replace FILTER I and II.	See Complete User manual. See "Replace filters" on pages 28-30.
	The Inlet Grid Filter is blocked.	See Complete User manual. See "Clean the Inlet Grid Filter" on page 35.
	The inlet water pressure is too low.	Make sure that inlet water tubing is the proper size as specified in the "REQUIREMENTS FOR INLET WATER to water purifier" on pages 47-48.
	Pro 400: Replace FILTER II. Pro 600: Replace FILTER I and II.	See Complete User manual. See "Replace filters" on pages 28-30.
	The inlet water pressure is too low. The water purifier has stopped.	The water purifier will try to restart automatically. Make sure that the inlet water pressure is sufficient. If necessary, replace the filters. See "Replace filters" on pages 28-30.
		Press and hold the Button to restart the water purifier. Release the Button when the FILTER I light and STOP light go out.
	FILTER I or FILTER II is blocked.	Make sure that there is nothing in the filters that may be blocking water flow. If necessary, replace filters. See "Replace filters" on pages 28-30.
	The Inlet Grid Filter is blocked.	See "Clean the Inlet Grid Filter" on page 35
	The inlet water pressure is too low.	Install a pressure boosting pump to increase the inlet water pressure. Check the parts that may influence the inlet water pressure. This includes the inlet water line, the Inlet Grid Filter, FILTER I, or any External Filters placed in front of Pro. Make sure the inlet water tubing is the proper size specified in the "REQUIREMENTS FOR INLET WATER to water purifier" on pages 47-48.
	The water purifier has stopped. The purified water quality is too low.	Disconnect the water purifier from power. Connect it again to start the automatic flush. Do this 2 times. If the problem persists, do not use the water. Contact your Bluewater dealer.

Symptom	Cause	Solution
	The inlet water TDS/Conductivity has increased above the recommended inlet water requirements. LEDs are lit, but Pro does not stop.	Disconnect the water purifier from power. Connect it again to start the automatic flush. If the problem persists, do not use the water. Contact your Bluewater dealer.
	The inlet water quality sensor is not working correctly. LEDs are lit, but Pro does not stop.	Disconnect the water purifier from power. Connect it again to start the automatic flush. If the problem persists, do not use the water. Contact your Bluewater dealer.
	The leak protection system has been activated.	Disconnect the water purifier from power and clean any water from the base plate of Pro. Connect the unit to power again and observe for any possible leakage of water. If the problem persists, contact your Bluewater dealer.
	The "Commissioning flush" procedure is ongoing.	Please allow Pro to complete the "Commissioning flush", do not disconnect the power, do not press the Button, and do not close the pure water faucet. The flush can take up to 54 minutes.
	The "Commissioning flush" procedure has been interrupted due to low inlet water pressure.	Make sure that the inlet water pressure is sufficient. Press the Button to restart the water purifier.
	The "Commissioning flush" procedure has been interrupted.	Open the purified water faucet and verify that the CV rinse function is open if your model is equipped with this feature.
The flow rate from the purified water faucet is low.	The purified water tubing has been sharply bent or blocked.	Make sure that there are no sharp bends in the purified water tubing and that it can move freely.
	The water purifier needs to be descaled.	See "Descal" on pages 31-34 .
The water purifier starts and stops intermittently or repeatedly.	The water purifier may be performing its 12 hour standby flush. This flush lasts for 30 seconds. There may be possible leaks between the water purifier and the purified water faucet, valve, tank, or reverse osmosis purified water approved appliance.	Examine all the tubing and fitting connections for possible leakage.
		Make sure that the ends of the water tubes are circular, squarely cut, and have no burrs or scratches.
		Make sure that the purified water faucets are watertight and do not leak. If there are any valves, make sure they are watertight when they are closed.
There is a bad smell from the water purifier.	Possible Microbial (bacterial) growth in the water purifier due to the water purifier not being used for a long period of time.	Pro may need to be disinfected. See "Use disinfectant to clean the system" on pages 37-40 .

Product performance

The Bluewater Pro water purifier has been tested according to NSF/ANSI 58 for reduction of the substances listed below:

- TDS
- Chromium(+3)
- Lead
- Arsenic(+5), also known as pentavalent arsenic, As(+5), As(V), or arsenate.

The concentration of the indicated substances in water entering the system was reduced to a concentration less than or equal to the permissible limit for the water leaving the system, as specified in NSF/ANSI 58.

See the performance data sheet on www.bluewatergroup.com for more details. Here you will find information about the conditions related to the reduction efficiency of Arsenic (+5) and why other forms of arsenic may not be removed to the same extent

Bluewater is a world leading water purification company. Headquartered in Stockholm, Sweden, the company helps people and businesses globally enjoy the health and wellbeing benefits of cleaner, healthier tap water.

Bluewater innovates, makes, and sells compact water purifiers that harness the company's patented reverse osmosis technology to remove virtually all pollutants from tap water, including lead, bacteria, pesticides, medical residues, chlorine, and limescale.

Please visit us at bluewatergroup.com



BLUEWATER

Danderydsgatan 11
SE-114 26 Stockholm
Sweden

E: info@bluewatergroup.com

bluewatergroup.com

